

목재 길이 / 갯수 / 모양

A 180Cm=10개

B 173Cm=4개

C 122Cm=2개

D 40Cm=20개

E 34Cm=2개

1

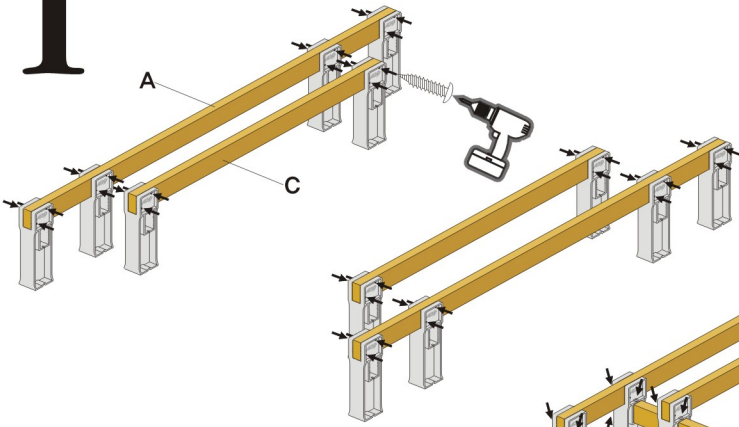

2

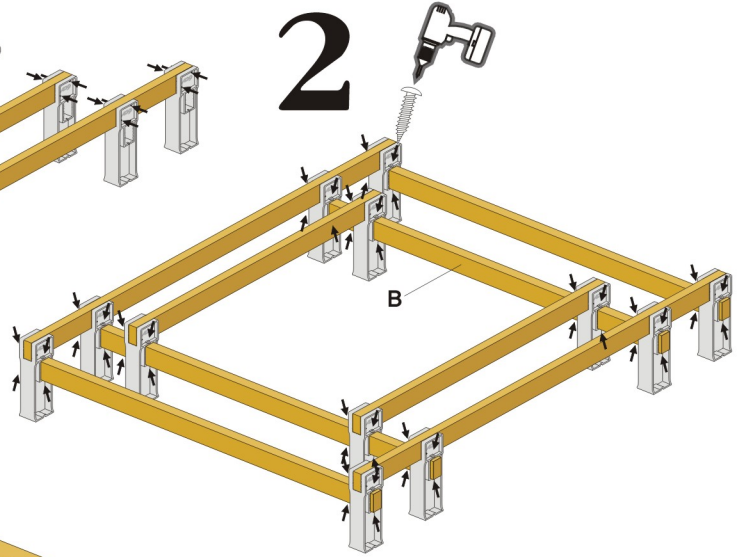

3

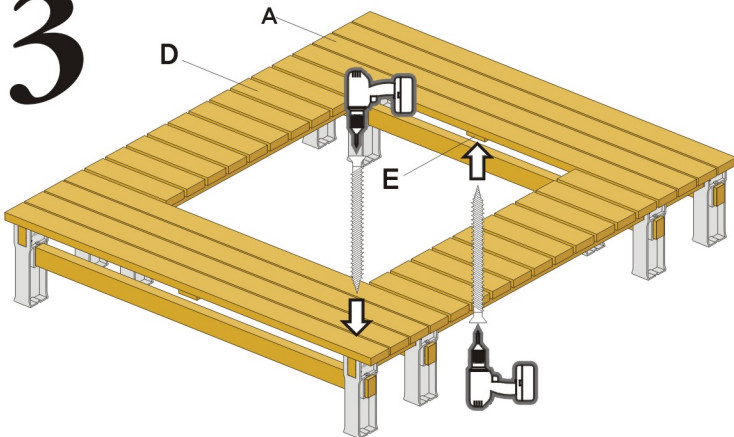

나사결합

- ↓ 프레임에 가로대를 태핑나사로 결합
- ↙ 가로대에 상·좌판을 병목나사로 결합

준비공구

